

## DUEVO MID LED High Bay Fitting Series 3301/3302...

### Applications:

Production areas and warehouses, cool storage facilities, walkways in shelve areas, driveways etc.

### Design:

Two versions are available: 1 (3301...) or 2 (3302...) LED-segments.

Housing: Die-cast aluminum, DB 702N (mica-iron paint, grey). LED-segment(s) with LED modules, optics behind tem-

pered safety glass (IK08). ECG segment with integrated electronic control gear, prewired on terminals.

Light distribution: Without optic wide beam, with optics wide (B), narrow-wide (TB) or narrow beam (T), respectively oval optics (TO) for illumination of aisles in rack areas.

Entries: 1 gland and 1 blind plug M25 x 1,5. Mounting: see Accessories.

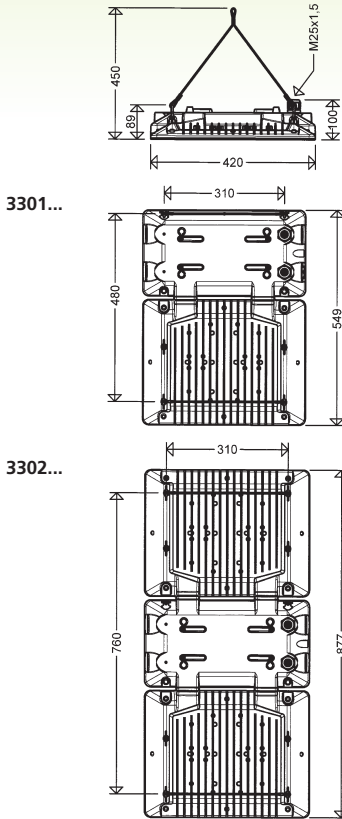

3301...

3302...

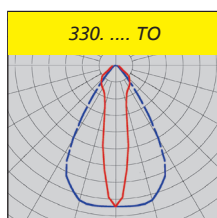
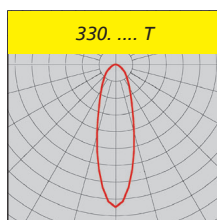
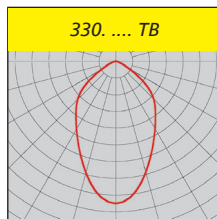
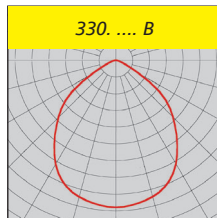
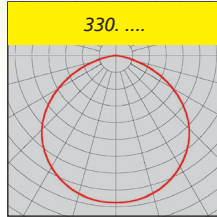

### Technical Data:

LED module: Complying Zhaga, 4,000K, CRI > 80, lifetime L<sub>70</sub> > 100,000h at max. ambient temperature (see notes)

ECG: 220-240V, 50/60Hz, overload and s.

ECG: 220-240V, 50-60Hz, Surge voltage resistance 4kV, overload and short circuit protection.

Note: Due to the inrush current of the electronic ballasts, the maximum permissible number of light fittings per circuit breaker is limited.

Ambient temperature: -20°C up to +50°C / +60°C (see article tables).

### Options:

On request also available with the following configurations (please mention in your enquiry or order):

#### Output reduction:

With control phase (LR): via 230V control input. Control phase (LST) required. Switching via control phase (LST = 230V: 100%; LST = 0V: 50%). Further dimming levels possible.

#### Corridor Mode (DIMC)

#### DALI interface (DIMD)

Constant luminous flux function (CL): Luminous flux is kept on a constant level over the entire lifetime of the LED-modules.

### Further Options:

- 5,000K, light colour 850

- PMMA cover frosted (F) for glare limitation

- for low ambient temperatures down to -40°C (T40)

- for high ambient temperatures up to +80°C (H80)

- „▽“-marking for rooms with higher fire risk (D)

- high protection (HR) against corrosive atmospheres or harmful gases

- Version with additional threads:

- for swivel arm brackets (swivel range 0° - 45°)
- ball sports proof version with special ceiling fixings for sport halls

- for connection to group or central battery systems (ZB) or emergency mains respectively

- FastConnect connecting for electrical connection without accessing the internal terminal block

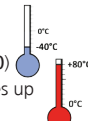

### Product highlights:

- high system lifetime of up to 100,000h at maximum ambient temperature
- optimized thermal management due to direct mounting of the LED modules to the housing and separate housings for ECG- and LED-modules, huge heat sink with excellent heat dissipation
- high quality ECG with overload and short circuit protection
- uniform illumination due to the „Multi-Layer Technology“ i.e. every individual LED illuminates the whole surface, the light curves of the individual LEDs are overlapping. No dark zones if any single LED would fail. The uniformity of the illumination is kept.
- colour rendering index CRI > 80
- variable electrical installation methods due to max. 8 cable entries (see options)
- future proof by using standardized LED-modules (Zhaga)

Properties, limitations and details for controlling LED-light fittings:

See "Technical Supplement"

All technical data is relevant at the time of print. Actual technical data can be found in the internet under [www.schuch.de](http://www.schuch.de).

Article no.	Type	Quantity of ECG	Dimmable	Wide beam	Narrow wide beam	Narrow beam	Energy efficiency class	Weight [kg] (without packing material)	Power consumption [W] **	Luminous flux [lm] **	Light output [lm/W]	Substitute for *
-------------	------	-----------------	----------	-----------	------------------	-------------	-------------------------	--	--------------------------	-----------------------	---------------------	------------------

### 3301...



... for ambient temperatures up to +50°C

1 LED segment

33010 0001	3301 L210	1	•				A++	8,0
33010 0002	3301 L210B	1	•				A++	8,1
33010 0013	3301 L210TB	1		•			A++	8,1
33010 0003	3301 L210T	1			•		A++	8,1
33010 0014	3301 L210TO	1			•		A++	8,0
33010 0200	3301 L210 DIMD	1	•	•			A++	8,1
33010 0201	3301 L210B DIMD	1	•	•			A++	8,1
33010 0212	3301 L210TB DIMD	1	•	•			A++	8,1
33010 0202	3301 L210T DIMD	1	•		•		A++	8,1
33010 0213	3301 L210TO DIMD	1	•		•		A++	8,1

135 20.200 150 HIE 400

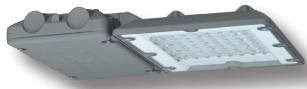
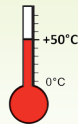

... for ambient temperatures up to +60°C

33010 0004	3301 L110 H60	1	•				A++	8,0
33010 0006	3301 L110B H60	1	•				A++	8,1
33010 0015	3301 L110TB H60	1		•			A++	8,1
33010 0008	3301 L110T H60	1			•		A++	8,1
33010 0203	3301 L110 DIMD H60	1	•	•			A++	8,0
33010 0205	3301 L110B DIMD H60	1	•	•			A++	8,1
33010 0214	3301 L110TB DIMD H60	1	•	•			A++	8,1
33010 0207	3301 L110T DIMD H60	1	•		•		A++	8,1
33010 0005	3301 L160 H60	1	•				A++	8,0
33010 0007	3301 L160B H60	1	•				A++	8,1
33010 0016	3301 L160TB H60	1		•			A++	8,1
33010 0009	3301 L160T H60	1			•		A++	8,1
33010 0204	3301 L160 DIMD H60	1	•	•			A++	8,0
33010 0206	3301 L160B DIMD H60	1	•	•			A++	8,1
33010 0215	3301 L160TB DIMD H60	1	•	•			A++	8,1
33010 0208	3301 L160T DIMD H60	1	•		•		A++	8,1

67 10.800 161 HME 250

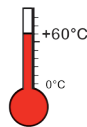

96 15.000 156 HIT 250/HME 400

### 3302...



... for ambient temperatures up to +50°C

2 LED segments

33020 0001	3302 L420	2	•				A++	13,1
33020 0002	3302 L420B	2	•				A++	13,3
33020 0013	3302 L420TB	2		•			A++	13,3
33020 0003	3302 L420T	2			•		A++	13,3
33020 0014	3302 L420TO	2			•		A++	13,3
33020 0200	3302 L420 DIMD	2	•	•			A++	13,2
33020 0201	3302 L420B DIMD	2	•	•			A++	13,4
33020 0212	3302 L420TB DIMD	2	•	•			A++	13,4
33020 0202	3302 L420T DIMD	2	•		•		A++	13,4
33020 0213	3302 L420TO DIMD	2	•		•		A++	13,4

270 40.400 150 2 x HIE 400

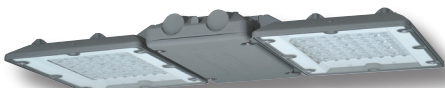
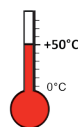

... for ambient temperatures up to +60°C

33020 0004	3302 L220 H60	2	•				A++	13,1
33020 0006	3302 L220B H60	2	•				A++	13,3
33020 0015	3302 L220TB H60	2		•			A++	13,3
33020 0008	3302 L220T H60	2			•		A++	13,3
33020 0203	3302 L220 DIMD H60	2	•	•			A++	13,1
33020 0205	3302 L220B DIMD H60	2	•	•			A++	13,3
33020 0214	3302 L220TB DIMD H60	2	•	•			A++	13,3
33020 0207	3302 L220T DIMD H60	2	•		•		A++	13,3
33020 0005	3302 L320 H60	2	•				A++	13,1
33020 0007	3302 L320B H60	2	•				A++	13,3
33020 0016	3302 L320TB H60	2		•			A++	13,3
33020 0009	3302 L320T H60	2			•		A++	13,3
33020 0204	3302 L320 DIMD H60	2	•	•			A++	13,1
33020 0206	3302 L320B DIMD H60	2	•	•			A++	13,3
33020 0215	3302 L320TB DIMD H60	2	•	•			A++	13,3
33020 0208	3302 L320T DIMD H60	2	•		•		A++	13,3

134 21.600 161 HIE 400

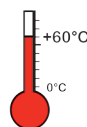

192 30.000 156 HIT 400

\* This date is a rough guideline. In individual cases a lighting calculation is required.  
\*\* see notes

Article no.	Type	Quantity of ECG	Dimmable	Wide beam	Narrow wide beam	Narrow beam	Energy efficiency class	Weight [kg] (without packing material)	Power consumption [W] **	Luminous flux [lm] **	Light output [lm/W]	Substitute for *
-------------	------	-----------------	----------	-----------	------------------	-------------	-------------------------	--	--------------------------	-----------------------	---------------------	------------------

## 3301/3302... IFS



### IFS Food/BRC/VDMA/HACCP

SCHUCH Light Fittings designed for food and beverage industry applications are in accordance with IFS Food/BRC/VDMA standards. They can be operated without restrictions in operations that must fulfill the HACCP Concept.

### for application in food industry areas

#### Applications:

Production halls in the food industry, locations which come under the requirements of the IFS Food (International Featured Standard, Food), BRC or HACCP, e.g. manufacture of food packaging.

#### Design:

With clear PC cover instead of the flat safety glass.

### ... for ambient temperatures up to +50°C

#### 1 LED segment

33010 0010	<b>3301 L210 IFS</b>	1	•				A++	6,9
33010 0011	<b>3301 L210B IFS</b>	1	•				A++	7,0
33010 0017	<b>3301 L210TB IFS</b>	1		•			A++	7,0
33010 0012	<b>3301 L210T IFS</b>	1			•		A++	7,0
33010 0209	<b>3301 L210 DIMD IFS</b>	1	•	•			A++	7,0
33010 0210	<b>3301 L210B DIMD IFS</b>	1	•	•			A++	7,1
33010 0216	<b>3301 L210TB DIMD IFS</b>	1	•		•		A++	7,1
33010 0211	<b>3301 L210T DIMD IFS</b>	1	•			•	A++	7,1

135 | 20.200 | 150 | HIE 400

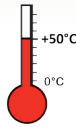

Optional also available for ambient temperatures up to +60°C



#### 2 LED segments

33020 0010	<b>3302 L420 IFS</b>	2	•				A++	11,0
33020 0011	<b>3302 L420B IFS</b>	2	•				A++	11,2
33020 0017	<b>3302 L420TB IFS</b>	2		•			A++	11,2
33020 0012	<b>3302 L420T IFS</b>	2			•		A++	11,2
33020 0209	<b>3302 L420 DIMD IFS</b>	2	•	•			A++	11,1
33020 0210	<b>3302 L420B DIMD IFS</b>	2	•	•			A++	11,3
33020 0216	<b>3302 L420TB DIMD IFS</b>	2	•		•		A++	11,3
33020 0211	<b>3302 L420T DIMD IFS</b>	2	•			•	A++	11,3

270 | 40.400 | 150 | 2 x HIE 400

\* This date is a rough guideline. In individual cases a lighting calculation is required.  
\*\* see notes



## Accessories / Spare Parts

Article no.	Type	
33001 9001	<b>3301/010</b>	spare safety glass for 1 LED segment
33001 9006	<b>3301/010 IFS</b>	PC cover for 1 LED segment, Version IFS
33001 9010	<b>3301/010 F</b>	PMMA-cover, frosted for glare limitation for 1 LED segment
25600 9000	<b>2560</b>	plastic gland M25x1,5
25720 9000	<b>2572</b>	plastic plug M25x1,5
33001 9004	<b>3301/3302 Y P</b>	1 pair of Y-ropes, (2-point-mounting)
33001 9002	<b>3301/3302 D</b>	1 pair of brackets for direct ceiling mounting <sup>1)</sup>
33001 9013	<b>3301/3302 SD</b>	vibration absorbing suspension device <sup>1)</sup>
<b>For the following mounting versions additional mounting holes are required on the luminaire. Please indicate the way of mounting when ordering the luminaire. Not retrofittable!</b>		
33001 9008	<b>3301 D BS</b>	1 pair of ceiling mountings, ball sports proof for series 3301 <sup>1)</sup>
33001 9009	<b>3302 D BS</b>	1 pair of ceiling mountings, ball sports proof for series 3302 <sup>1)</sup>
33001 9003	<b>3301 W</b>	1 swivel arm, adjustable, for wall mounting series 3301... <sup>1)</sup>
33001 9007	<b>3302 W</b>	1 swivel arm, adjustable, for wall mounting series 3302... <sup>1)</sup>

<sup>1)</sup> Version Sheet Steel painted. Optional available in stainless steel painted.